

PS LED Down Light DESIGNER PREMIUM



PROJECT

CATALOG #

TYPE

NOTES

The PS truly represents the next generation of fixed-mount LED down lights. It is meant for top-mounting, and is available with an optional copper cover. It is available with 3, 6 or 9LED boards and comes in all of our metal and powder coat finishes. The PS also includes a free mounting bracket that allows for tool-free servicing after initial installation.

Quick Facts

- Die-cast aluminum or brass
- Two-layer marine-grade anodization and powder coat finish
- Natural, powder coated, or antiqued brass finishes
- Cree® Integrated LEDs
- Color temperature filters
- Compatible with Luxor® technology
- Phase and PWM dimmable
- Input voltage: 10-15V

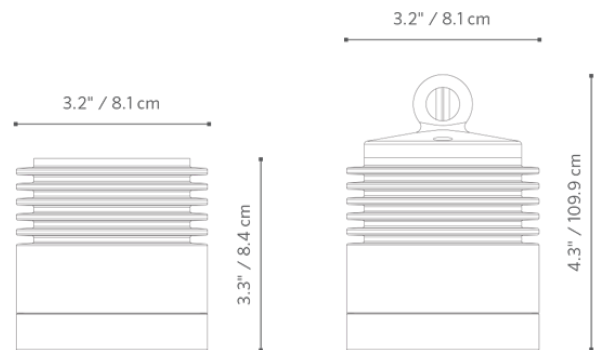

PS LED Down Light SPECIFICATIONS

Output	3LED	3LEDT	6LED	9LED	ZDC
Total Lumens (lm)	295	157	535	796	174
Input Voltage (V)	10 to 15	10 to 15	10 to 15	10 to 15	11 to 15
Input Power (W)	4.0	4.2	7.7	11.1	9.1
VA	4.4	4.5	9.3	12.2	11.0
Efficacy (Lumens/Watt)	75	44	69	70	33
Color Rendering Index (CRI)	83	--	83	83	--
Maximum Candela (cd)*					
Wide Flood (60°)	335	604	610	950	198
Luxor Compatibility					
Default	Zoning	--	Zoning	Zoning	--
ZD Option	Zoning/Dimming	Zoning/Dimming	Zoning/Dimming	Zoning/Dimming	--
ZDC Option	--	--	--	--	Zoning/Dimming/Color
Minimum Rated Life (L70 B10)	72,000 Hrs	50,000 Hrs	72,000 Hrs	72,000 Hrs	50,000 Hrs

* Information not available for Spot or Flood.

PS LED Down Light SPECIFICATIONS

FX Luminaire

FX Luminaire is an industry-leading manufacturer of landscape and architectural lighting products with a focus on the advancement of LED technology and digital lighting control with zoning, dimming, and color adjustment capabilities. We offer a full spectrum of specification-driven lighting fixtures that can be utilized to create elegant, cutting-edge landscape lighting systems for commercial or residential applications. Our products are available exclusively via our extensive professional distributor network.

Materials

Die-cast C360 brass housing and shroud with stainless steel set screws, mounting brackets, and fasteners.

LED

Integrated module with Cree LEDs. Gold-plated connectors and conformal coated for maximum reliability and corrosion resistance. Proprietary on-board intelligent driver uses firmware-controlled temperature regulation, maximizing LED life. Field upgradeable and replaceable, the LEDs are rated to 50,000 hrs. Maximum drive current: 1 A.

Optics

Polycarbonate color temperature adjustment lenses included with fixture: 2,700K (preinstalled), 3,900K (no lens), 4,500K, and 5,200K. Interchangeable optics for 10°, 20°, 30°-32°, or 55°-58° distributions ordered preassembled to fixture. Color temperature and beam angle lenses field serviceable. For additional color filters, spread lenses, hex baffles, etc., use MR-16 sized accessories (MR-16: 1.95" (50 mm) dia. x 1.1 mm thickness). Beam angle is calculated using LM-79 method for SSL luminaires.

Finish

Options of natural brass (copper finish or antiqued finish with brushed (Antique Bronze) or tumbled (Antique Tumbled) effect. Antique finishes sealed with a clear TGIC powder coat layer.

Hardware

Includes stainless steel mounting brackets for quick assembly. Tamper-resistant setscrew included.

Wiring

18 AWG (1 mm); SPT-1W; 220°F (105°C); 300V; 3.6' (1.1 m) length.

Sockets

Socket contains MoistureBlock™ technology, preventing moisture from wicking up into sealed areas of the fixture.

Power

Input 10-15 VAC/VDC 50/60 Hz. Remote transformer required (specify separately).

Housing

Die-cast C360 brass housing with capacity for 1LED, 3LED, 6LED, 9LED, or ZDC integrated LEDs.

Weight

2.5 lbs. (1.1 kg)

Lens

Tempered glass lens with shock resistance and high tolerance for thermal expansion and stress.

International Compliance

Compliant per IEC 60598-1 and IEC 60598-2-7 when used with custom installation kit ("WP-RD-PS-E-XX") accessory.

Ambient Operating Temperature

0°F to 140°F (-18°C to 60°C)

Sustainability

Innovation meets conservation in the design and manufacturing of our products. Where we can, we use recycled materials while maintaining superior functionality. Our LED products provide high quality light at optimal energy efficiency, lifespan, and durability.

Installation Requirements

Designed for installation in the downward lighting direction only.

Warranty

Listings



PS LED Down Light ORDERING INFORMATION

Fixture Control	Power	Hanging Option	Finish
PS [Default] Zone with Luxor, On/Off, Phase Dimmable	3 LED 4.0W/4.4VA	HB (available in powder coat finishes only)	BZ Bronze Metallic
ZD Zone/Dim with Luxor	3 LEDT Wildlife-Friendly Amber (585-595 nm)	[default]	FB Black
ZDC Zone/Dim/Color with Luxor	6 LED 7.7W/9.3VA		DG Desert Granite
	9 LED 11.1W/12.2VA		WI Weathered Iron
	[default ZDC option] 9.1W/11.0VA		SB Sedona Brown
			FW Flat White
			SV Silver
			BSAB Antique Bronze on Brass
			BSAT Antique Tumbled on Brass
			CUAB Antique Bronze on Copper
			CUAT Antique Tumbled on Copper
			CU Copper
			NP Nickel Plate
			BS Natural Brass



EXAMPLE FIXTURE CONFIGURATION: PS-ZD-3LED-BS-AB

** Available with ZD Luxor option and CU, AB, or AT finishes only

PS 3LED - Illuminance at a Distance

Distance	Center Beam fc	Beam Width	
Feet (Meters)	Foot-Candles (Lux)	Vertical : 17.9 °	Horizontal : 18 °
2.0' (0.6 m)	244 fc (2,626 lx)	0.6' (0.2 m)	0.6' (0.2 m)
4.0' (1.2 m)	61 fc (657 lx)	1.3' (0.4 m)	1.3' (0.4 m)
6.0' (1.8 m)	27 fc (292 lx)	1.9' (0.6 m)	1.9' (0.6 m)
8.0' (2.4 m)	15 fc (164 lx)	3' (0.8 m)	3' (0.8 m)
10.0' (3.1 m)	10 fc (106 lx)	3' (0.8 m)	3' (0.8 m)

PS 3LEDT - Illuminance at a Distance

Distance	Center Beam fc	Beam Width	
Feet (Meters)	Foot-Candles (Lux)	Vertical : 20.8 °	Horizontal : 20.8 °
2.0' (0.6 m)	151 fc (1,625 lx)	0.7' (0.2 m)	0.7' (0.2 m)
4.0' (1.2 m)	38 fc (406 lx)	1.5' (0.5 m)	1.5' (0.5 m)
6.0' (1.8 m)	17 fc (181 lx)	2' (0.6 m)	2' (0.6 m)
8.0' (2.4 m)	9 fc (101 lx)	3' (0.8 m)	3' (0.8 m)
10.0' (3.1 m)	6 fc (65 lx)	3.7' (1.1 m)	3.7' (1.1 m)

PS 6LED - Illuminance at a Distance

Distance	Center Beam fc	Beam Width	
Feet (Meters)	Foot-Candles (Lux)	Vertical : 16.7 °	Horizontal : 17.1 °
2.0' (0.6 m)	506 fc (5,442 lx)	0.6' (0.2 m)	0.6' (0.2 m)
4.0' (1.2 m)	126 fc (1,361 lx)	1.2' (0.4 m)	1.2' (0.4 m)
6.0' (1.8 m)	56 fc (605 lx)	2' (0.6 m)	2' (0.6 m)
8.0' (2.4 m)	32 fc (340 lx)	2' (0.6 m)	2' (0.6 m)
10.0' (3.1 m)	20 fc (217 lx)	3' (0.8 m)	3' (0.8 m)

PS 9LED - Illuminance at a Distance



Distance	Center Beam fc	Beam Width	
Feet (Meters)	Foot-Candles (Lux)	Vertical : 16.6 °	Horizontal : 16.1 °
2.0' (0.6 m)	569 fc (6,125 lx)	0.6' (0.2 m)	0.6' (0.2 m)
4.0' (1.2 m)	142 fc (1,532 lx)	1.2' (0.4 m)	1.1' (0.3 m)
6.0' (1.8 m)	63 fc (680 lx)	2' (0.6 m)	2' (0.6 m)
8.0' (2.4 m)	36 fc (383 lx)	2' (0.6 m)	2' (0.6 m)
10.0' (3.1 m)	23 fc (245 lx)	3' (0.8 m)	3' (0.8 m)



PS ZDC - Illuminance at a Distance

Distance	Center Beam fc	Beam Width
Feet (Meters)	Foot-Candles (Lux)	Vertical : 49.5 °
2.0' (0.6 m)	50 fc (533 lx)	2' (0.6 m)
4.0' (1.2 m)	12 fc (134 lx)	3' (0.8 m)
6.0' (1.8 m)	6 fc (59 lx)	6' (1.7 m)
8.0' (2.4 m)	3 fc (33 lx)	7' (2.3 m)
10.0' (3.1 m)	1.9 fc (21 lx)	9' (2.8 m)

PS LED Down Light ORDERING INFORMATION



MOUNTING OPTIONS: Specify Separately

Mounts	Catalog No.	
Hanging Cable Lock	250021820000	
Hanging Bracket for the PS Down Light	PS-HB-XX*	

Mounts	Catalog No.	
Hanging Cable	250021830000	
Round Wall Plate for the PS Down Light	WP-RD-PS-XX*	

PS LED Down Light ORDERING INFORMATION

POWER OPTIONS: Specify Separately

Power	Catalog No.	
Plug-In Transformer, 6 W	MT-6W	
Surge Protection Module	SURGE-MOD	
-		

Power	Catalog No.	
Step-Down Transformer, UV (120/277 V to 12 V)	ST-UV	